

Article number: 51030405000010

Description: Vibration damper GS-M2
80x80x2000-15, NR shore 57

Measures

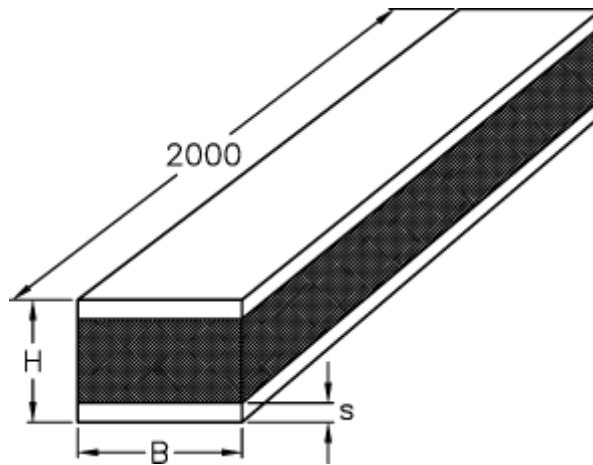

B = 80

H = 80

S = 15